

KIT
RENAULT TRAFIC
OPEL VIVARO
NISSAN PRIMASTAR
FIAT TALENTO

DE	Montageanleitung für die Halterungen
EN	Installation instructions for brackets
FR	Instructions de montage pattes
ES	Instrucciones de instalacion de los estribos
IT	Istruzioni di montaggio staffe

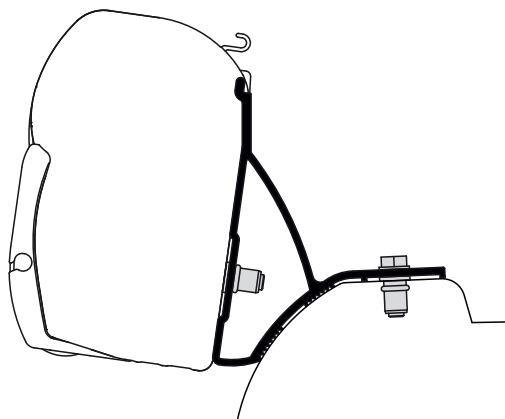

Fiamma F45

DE Verpackungsinhalt
FR Contenu de l'emballage
IT Contenuto dell'imballo

EN Package contents
ES Contenido del embalaje

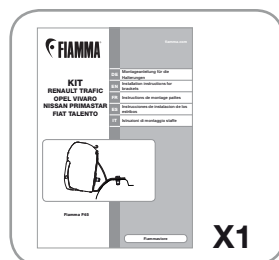
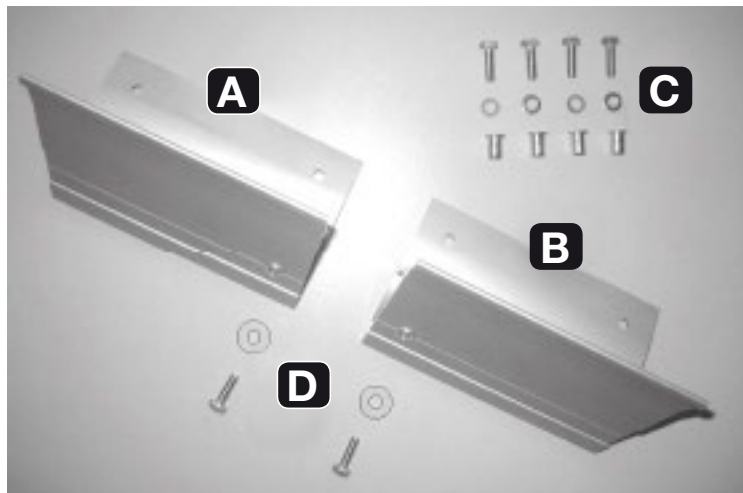

- DE Anbringung für die Halterungen am Fahrzeug
EN Installation of the brackets on the vehicle
FR Installation des pattes sur le véhicule
ES Instalación de los estribos sobre el vehículo
IT Montaggio delle staffe sul mezzo

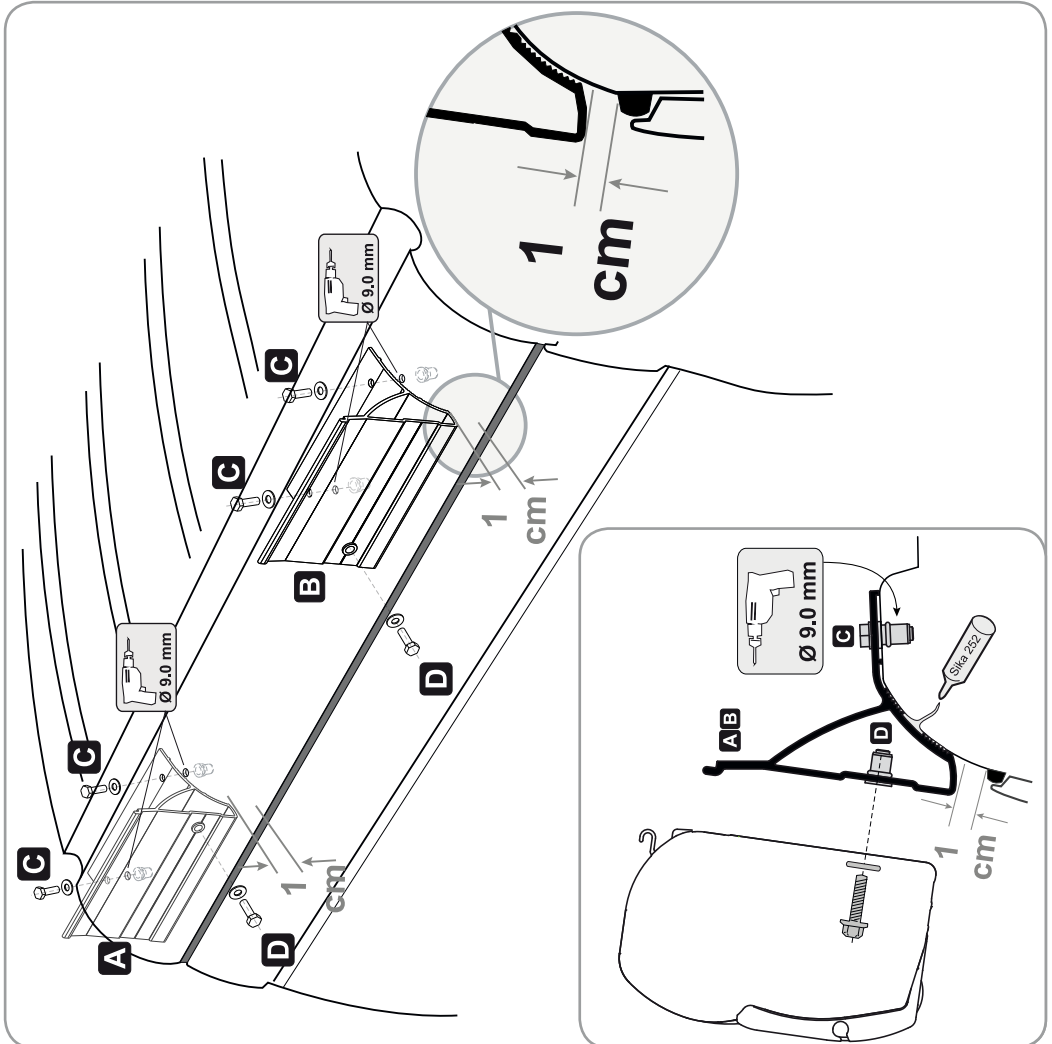

F45 S 230

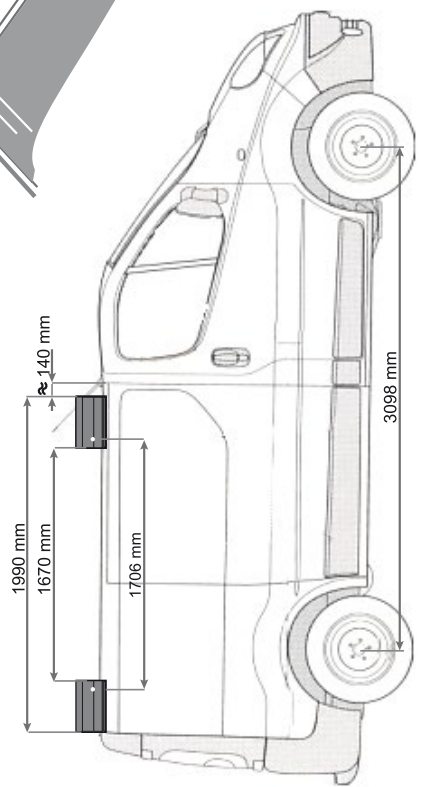
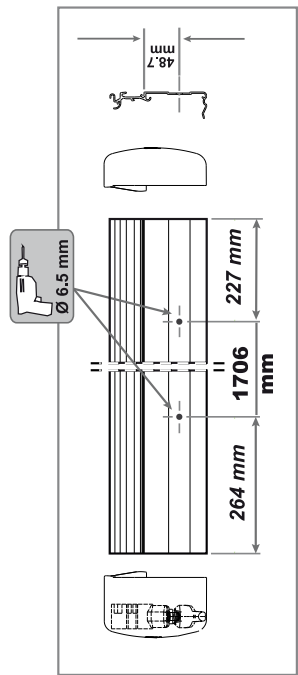
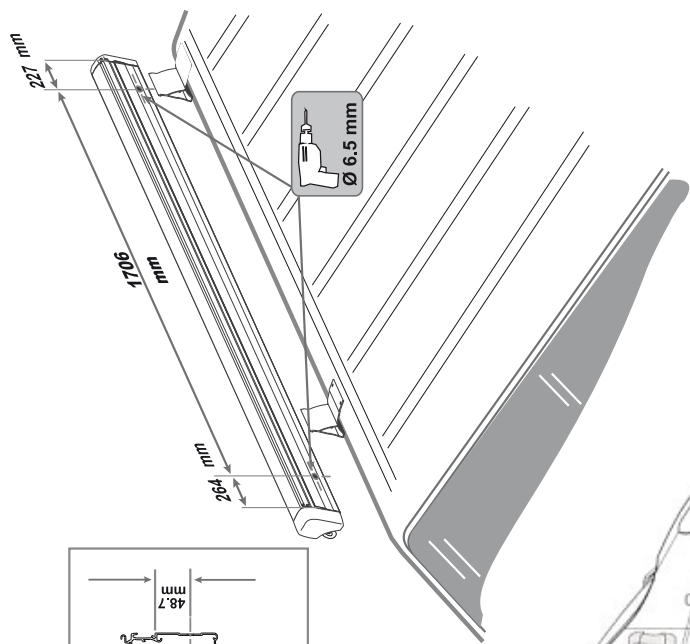

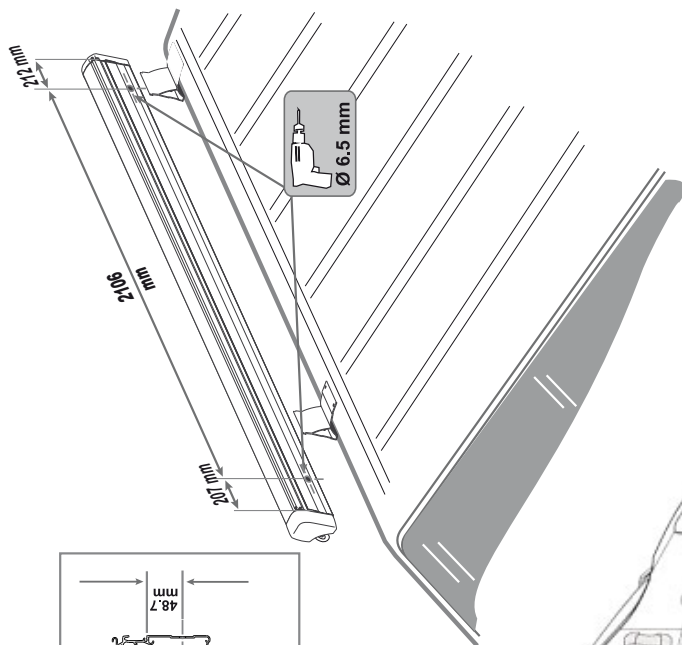

F45 S 260

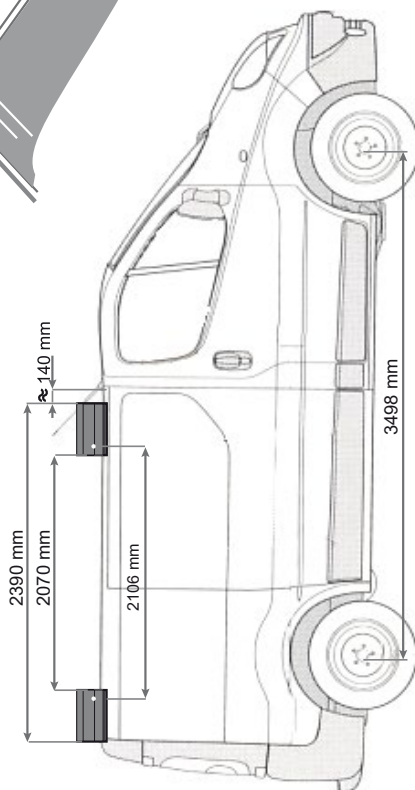
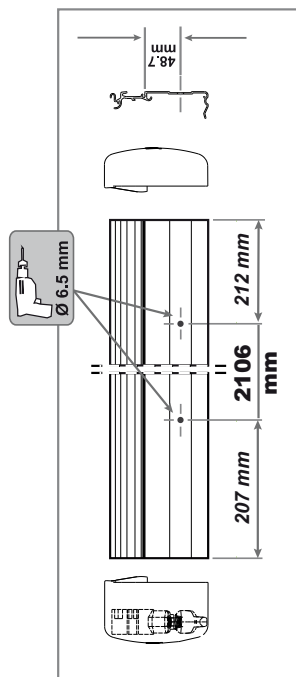

DE Anbringung der Markise auf die Halterungen

EN Installation of the awning on the brackets

FR Installation du store sur les pattes

ES Fijación del toldo sobre los estribos

IT Montaggio del tendalino sulle staffe

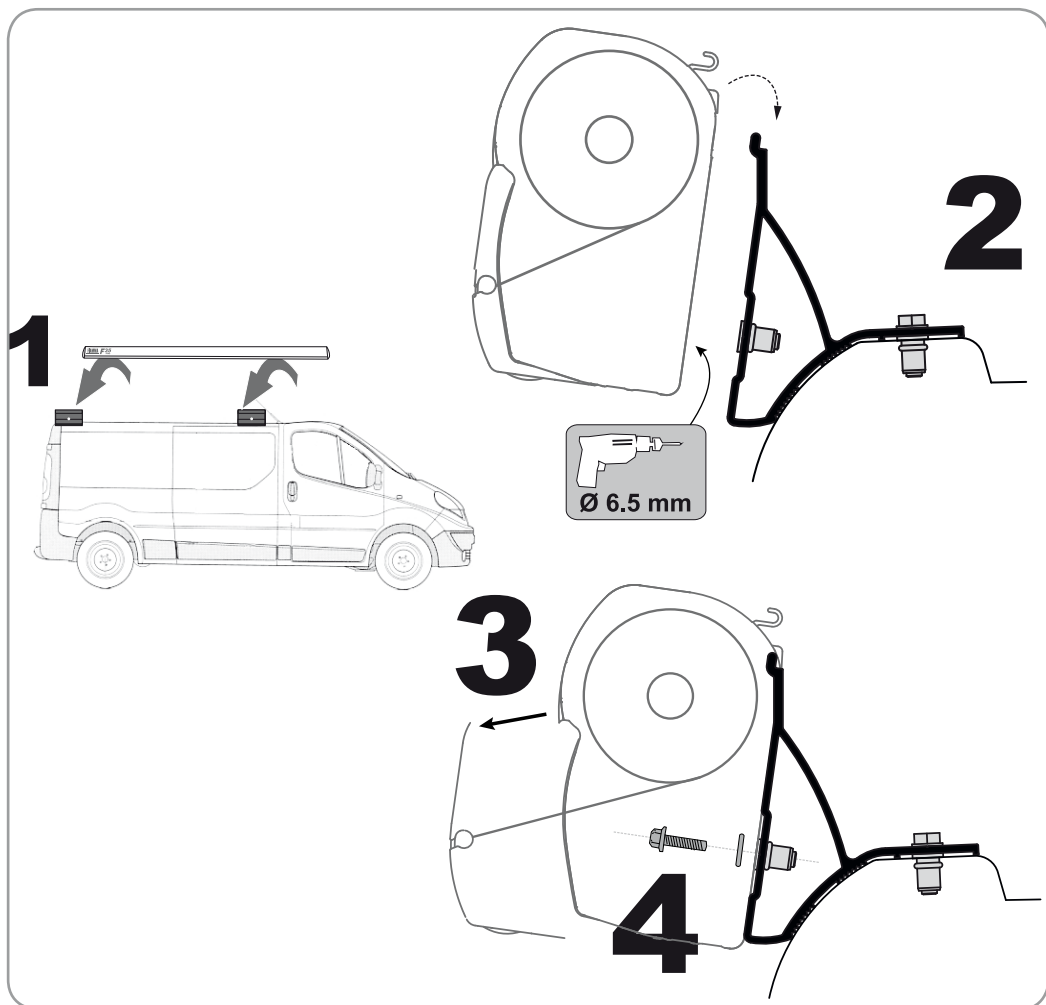

DE **ACHTUNG** Regelmäßig die Befestigung für die Halterungen kontrollieren. Achten Sie vor allem nach den ersten Kilometern darauf, dass sich die Haltebügel nicht verschoben haben.

EN **ATTENTION** Periodically check the brackets to make sure they are firmly attached (especially after the first kilometers) make sure the bolts are not loose and that holding brackets have not shifted.

FR **ATTENTION** Contrôler périodiquement l'état de fixation des pattes (surtout après les premiers kilomètres) en s'assurant que les supports de fixation n'aient pas bougé.

ES **CUIDADO** Controlar periódicamente el estado de fijación de los estribos (sobre todo después de los primeros Kms) asegurándose que no se desplacen.

IT **ATTENZIONE** Controllare periodicamente lo stato di fissaggio delle staffe (soprattutto dopo i primi chilometri) assicurandosi che le stesse non si siano mosse e che i serraggi siano corretti.

DE Bitte halten Sie sich beim Gebrauch für die Markise an die Gebrauchsanweisung.

EN When using the awning please follow the instructions of the product.

FR Pour l'utilisation du store, se référer aux instructions du store même.

ES Para el uso del toldo, atenerse a las instrucciones que se encuentran en el producto.

IT Per l'utilizzo del tendalino, attenersi alle istruzioni presenti nel prodotto.



fiamma.com

All rights reserved.

Fiamma S.p.A. reserves the right to modify at any time, without notice, prices, materials, specifications and models or to cease production of any model.

98655Z021

R0_IS_98690-393_revA

Fiammastore

Fiamma SpA - Italy
Via San Rocco, 56
21010 Cardano al Campo (VA)